

MODEL# A-8247

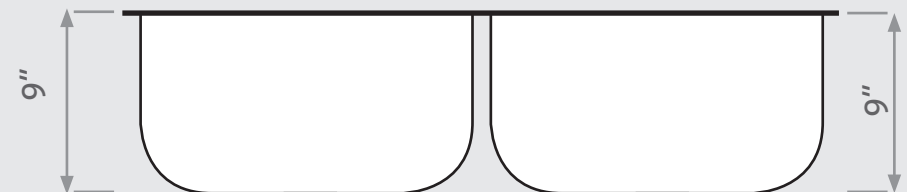
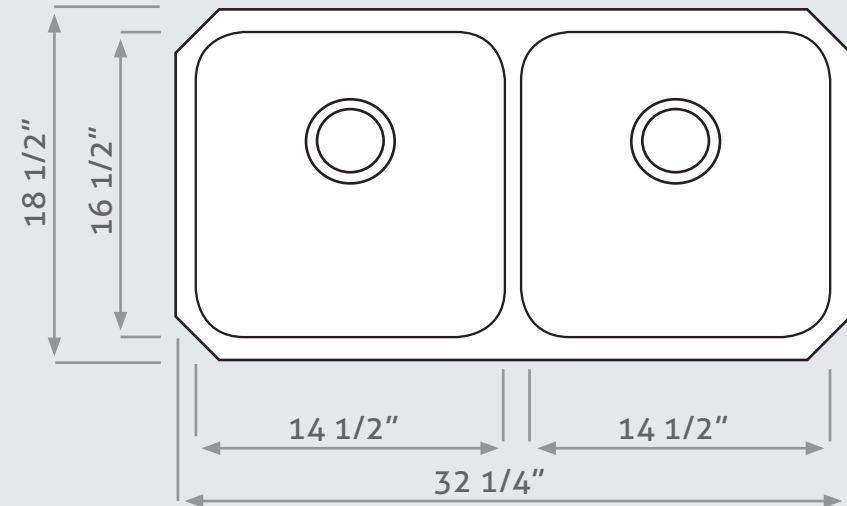

FEATURES

- 304 STAINLESS STEEL
- 18 & 16 GAUGE AVAILABLE
- SOUND DAMPENING PADS
- SOUND ABSORBING UNDERCOATING

AVAILABLE ACCESSORIES

- STAINLESS STEEL GRID
- DELUXE STRAINER

CODES

ASME A112.19.2-2013/CSA B45.1-13

