

MODEL# AR-3219

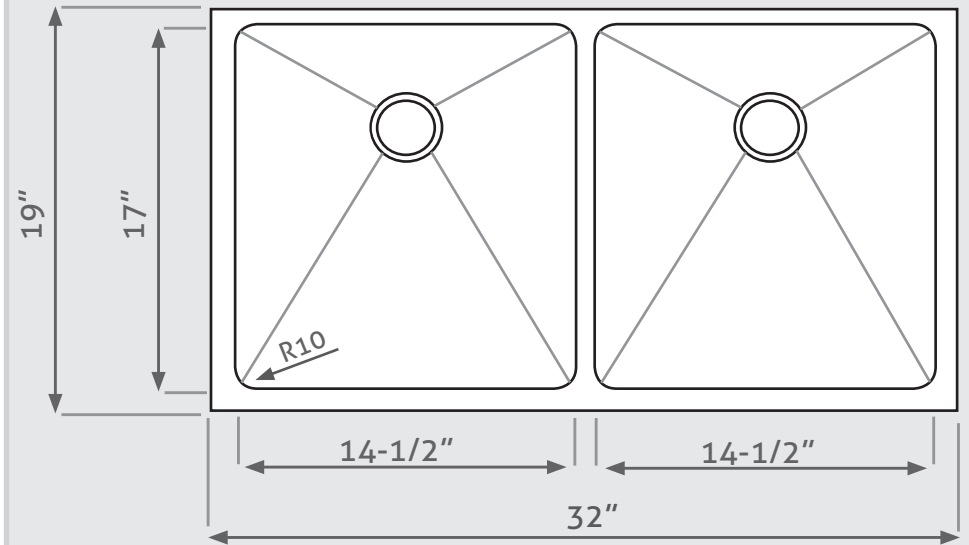

FEATURES

- 304 STAINLESS STEEL
- 16 GAUGE
- SOUND DAMPENING PADS
- SOUND ABSORBING UNDERCOATING

AVAILABLE ACCESSORIES

- STAINLESS STEEL GRID
- DELUXE STRAINER

CODES

ASME A112.19.2-2013/CSA B45.1-13

